



Polarized-Media Electronic Air Cleaner

Item	Description
1	Replacement Media Pad
2	Powerhead (inside channel)
3	Power Cord
4	Electrode Insulator Button
5	Air Cleaner Latch
6	Power ON Light
7	Label "Unplug before Opening"
8	Power Input Jack
9	Label
10	Electrode
11	Model / Power Rating Label
12	Air Cleaner Size Label
13	Patent Label
14	Hinge
15	Screen
16	Frame
17	Spline

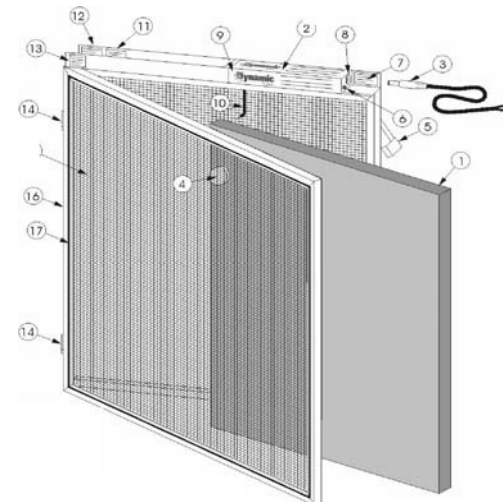
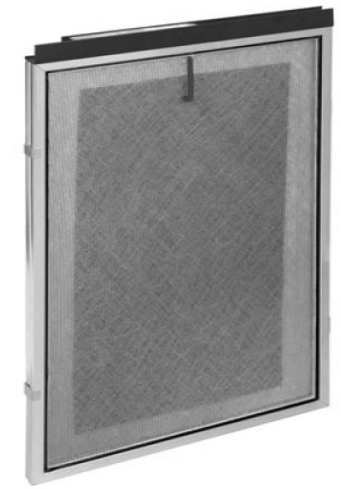

Figure 7

**FOR TECHNICAL SUPPORT
Call 1-800-578-7873**

Installation Instructions & Consumer Information



Section I. Installation Instructions

- 1) Turn the thermostat fan switch to the "OFF" position.
- 2) Turn off power to the furnace/air handler.
- 3) Remove the existing filter from the furnace/air handler or return air grille.
- 4) Wiring to the on-board transformer or integrated furnace control:

NOTE: ONLY A QUALIFIED ELECTRICIAN SHOULD PERFORM ELECTRICAL WIRING.

If there is a terminal strip such as the one shown in figure 1, connect the black wire of the power cord to the "Common" terminal (typically the "C" terminal) and the black wire with the white stripe to the "Hot" 24vac terminal (typically the "R" terminal). Output from the 24vac transformer may vary due to local line voltage fluctuations. Outputs up to 28vac are acceptable.

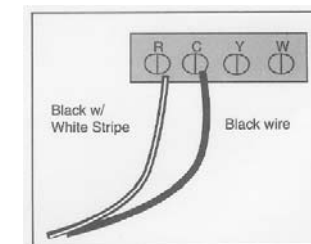

Figure 1

If the terminals are unmarked, or to confirm the markings, use a voltmeter to find the Common and "Hot" 24vac terminals:

- a. Turn off the power to the furnace/air handler and the transformer.
- b. With the voltmeter set to "Continuity", check for continuity between each terminal and the metal frame of the furnace/air handler. Choose a spot on the furnace/air handler such as a screw or unpainted edge, where a good electrical contact can be found.
- c. If continuity is found between one of the terminals and the furnace/air handler, that terminal will be the Common terminal.
- d. With the power on to the transformer, use the voltmeter to locate the 24vac terminal.

Dynamic Air Quality Solutions
P.O. Box 1258
Princeton, NJ 08542
Tel: (800) 578-7873
Fax (609) 924-8524
www.DynamicAQS.com

Specifications are subject to change without notice. Dynamic and Dynamic Air Quality Solutions are registered trademarks of Environmental Dynamics Group, PO Box 1258, Princeton, NJ 08542

If a Common or 24vac terminal cannot be located, it will be necessary to install a separate transformer. If a hard-wired transformer is used, an isolated class II transformer is recommended. The transformer must be installed according to local codes and ordinances.

5) If necessary, route the power cord through the furnace/air handler cabinet to the filter rack area. If an existing access hole is not available, drill a 7/16" hole. A grommet is provided to fit a 7/16" hole (fig 2). The cord should be run so that it is not crimped or abraded and should have enough slack to allow the air cleaner to be easily removed for routine maintenance. Position the power cord slack to keep it away from the furnace/air handler blower and other moving parts.

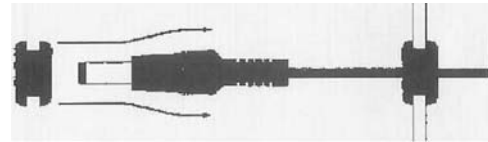

Figure 2

- 6) Install the air cleaner into the filter rack or return air grille.
- 7) Plug the power cord into the air cleaner once it is securely in place (fig 3).
- 8) Close the filter access door or grille.
- 9) Turn on the power to the furnace/air handler. The power indicator light on the air cleaner should illuminate.
- 10) Turn the thermostat fan switch to the "ON" position.

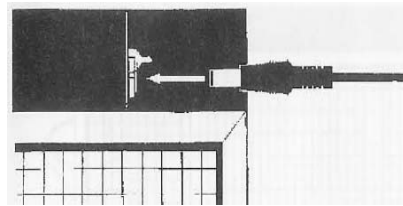

Figure 3

NOTE: For best air cleaning efficiency and optimum comfort, the furnace/air handler blower should be run continuously with the fan switch in the "ON" position rather than in the "AUTO" position.

- 11) If arcing occurs within the air cleaner, see the instructions in section III for replacing the air cleaner Media Pad.
- 12) Affix the caution sticker and Media Pad Replacement Record in a prominent location near the air cleaner.

Section II. Optional Plug-In Transformer

As an optional accessory, a plug-in transformer (part no. A412402) is available to plug into any 110-Volt (AC) outlet to provide 24-Volt (AC) power to the unit.

WARNING: DO NOT SUBSTITUTE OTHER 110VAC-24VAC TRANSFORMERS AS DAMAGE COULD RESULT TO THE UNIT ELECTRONICS AND VOID THE AIR CLEANER WARRANTY.

Section III. Maintenance and Media Pad Replacement

Replacement Media Pads are available from your heating and air conditioning contractor or by ordering online at www.DynamicAQS.com.

WARNING: WHENEVER INSTALLING OR REMOVING THE AIR CLEANER, THE POWER TO THE FURNACE/AIR HANDLER MUST BE TURNED OFF. CARE SHOULD BE TAKEN NOT TO LET THE JACK TOUCH ANY GROUNDED OR METAL SURFACES. ALTHOUGH THE JACK IS SHIELDED, IT IS POSSIBLE FOR THE CENTRAL POWER INSERT TO CONTACT GROUND WHICH COULD RESULT IN DAMAGE TO THE TRANSFORMER OR ELECTRONICS.

- 1) Turn the thermostat fan switch to the "OFF" position.
- 2) Turn off power to the furnace/air handler.
- 3) Open the filter access door or grille.
- 4) Unplug the power supply cord from the air cleaner powerhead.
- 5) Remove the air cleaner from the filter rack or return air grille.
- 6) Open the air cleaner (fig 4), remove the old media pad and discard.



Figure 4

- 7) If dust has accumulated on the outer screen of the air cleaner, clean with a dry brush or vacuum.
- 8) Position the new replacement media pad so that it is centered within the air cleaner frame (fig 5).
- 9) Close and re-latch the air cleaner.
- 10) Return the air cleaner to its location in the furnace/air handler or return air grille.
- 11) Plug the power supply cord into the air cleaner once it is securely in place (fig 6).
- 12) Close the filter access door or grille.
- 13) Switch the thermostat back to the "ON" position. For optimum results, the furnace or air handler should be run continuously with the fan switch in the "ON" position, rather than the "AUTO" position.
- 14) Because of variations in humidity and temperature, the new media pad may make a slight snapping sound when first installed. This is normal and should stop within 24 hours of operation.

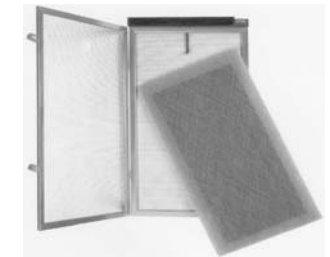

Figure 5

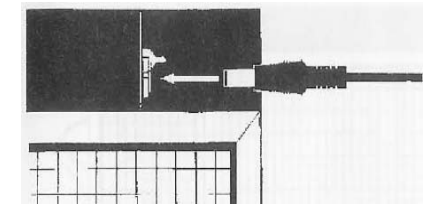

Figure 6

NOTE: Media pads generally last 3 to 4 months, depending on household conditions. In a new installation, however, it is suggested that the media pad be inspected and/or replaced after one month of operation due to the initial cleanup of contaminants. Only Genuine Dynamic replacement media pads should be used with your Dynamic Air Cleaner. Failure to do so could cause damage to the air cleaner, alter air cleaner performance, and/or void your warranty.

WARNING: FAILURE TO CHANGE THE MEDIA PAD ON A REGULAR BASIS COULD REDUCE AIRFLOW AND CAUSE DAMAGE TO THE HEATING AND COOLING SYSTEM.

Section IV. Replacement Parts

- 1) Maintenance is limited to periodic replacement of the air cleaner media pads. This is typically done every 3 to 4 months. Use only genuine Dynamic replacement media pads.
- 2) Replacement Media Pads can be ordered from your heating and air conditioning contractor or by ordering online at www.DynamicAQS.com. Have the model number or unit size available when calling. Refer to the size label on the unit (item 12 in figure 7) for the unit size. Air cleaner media pads are sized according to the size of the overall air cleaner and NOT the size of the media pad itself.
- 3) When giving dimensions, the first dimension given should be the length of the side with the powerhead.